

Technical data

# LINEAR

Scheda Tecnica

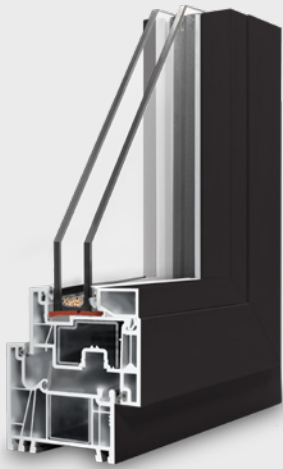

Sistema doppio vetro  
Double glass system

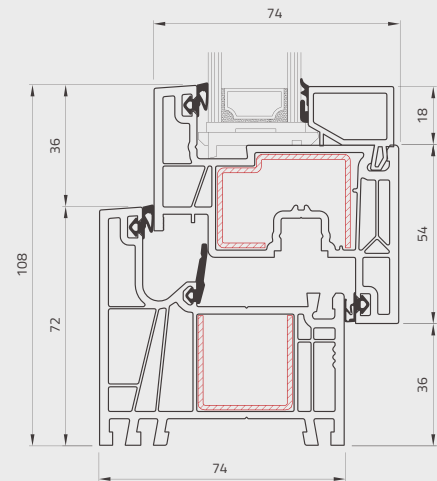

Sistema triplo vetro  
Triple glass system

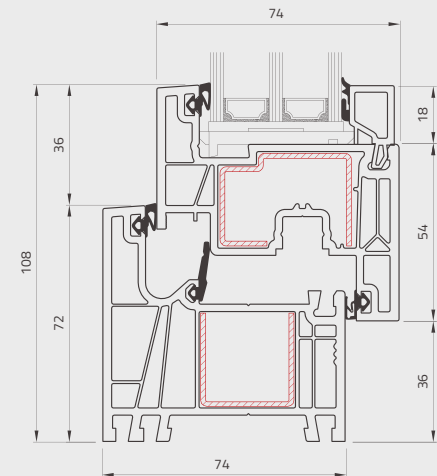

Trasmittanza termica fino a  $U_w = 1,0 \text{ W/m}^2\text{K}$

Permeabilità all'aria fino a **Classe 4**

Tenuta all'acqua battente fino a **Classe 9A**

Resistenza al vento fino a **Classe C5/B5**

Anti-effrazione fino a **RC2**

Insonorizzazione fino a **47db**

Thermal transmittance up to  $U_w = 1,0 \text{ W/m}^2\text{K}$

Air permeability up to Class 4

Impact water tightness up to Class 9A

Wind resistance up to Class C5 / B5

Anti-burglary up to RC2

Soundproofing up to 47db

## Nodo Centrale

Central knot

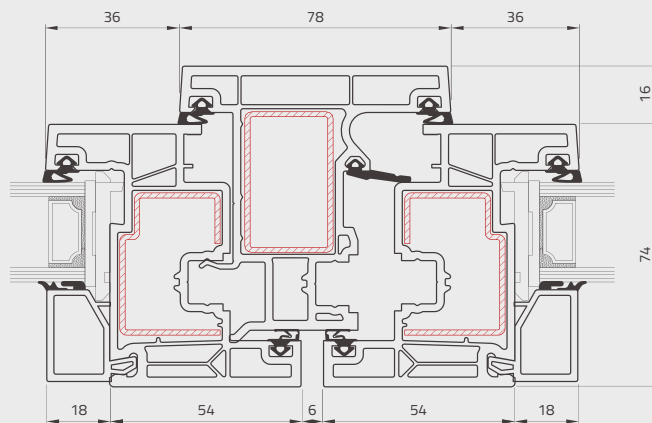

## Telai

Frames

Telaio piano  
Flat frame

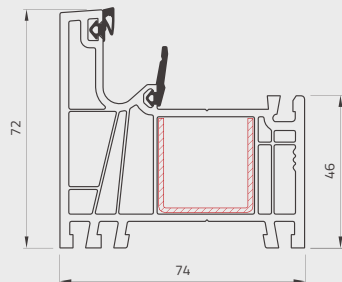

Telaio a ZETA 35 mm  
ZETA frame 35mm

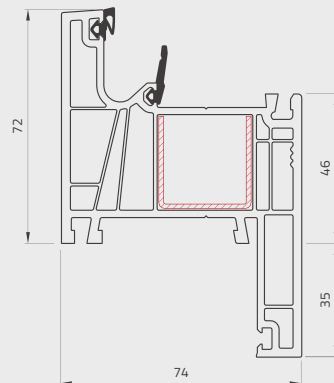

Telaio a ZETA 60 mm  
ZETA frame 60mm

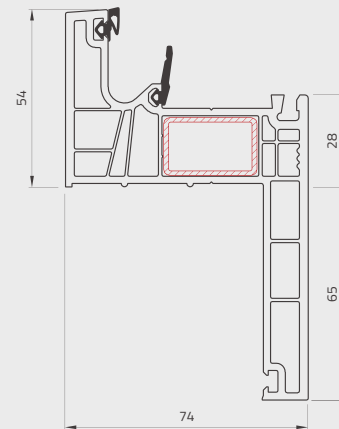

## Fermavetri

Glazing bead

Squadrato  
Squared

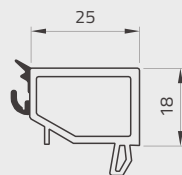

Spessore vetro 26-28mm  
Glass thickness 26-28mm

Squadrato  
Squared

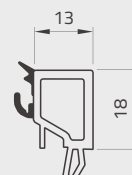

Spessore vetro 38-40mm  
Glass thickness 38-40mm