

Technical data

BE73

Scheda Tecnica

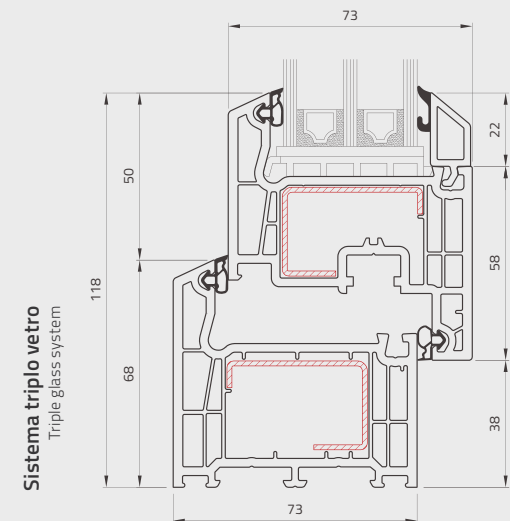
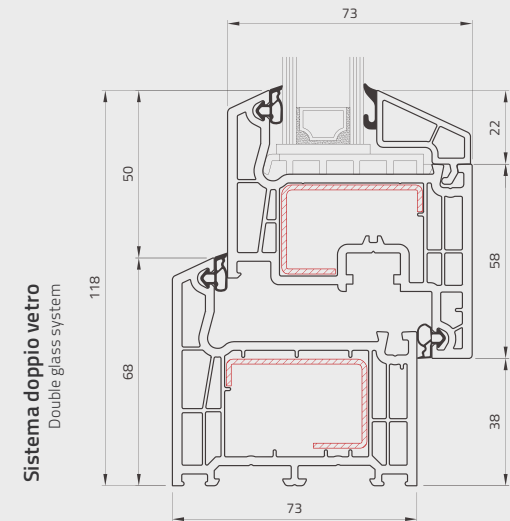

Trasmittanza termica fino a $U_w = 1,3 \text{ W/m}^2\text{K}$

Permeabilità all'aria fino a **Classe 4**

Tenuta all'acqua battente fino a **Classe 8A**

Resistenza al vento fino a **Classe C5/B5**

Anti-effrazione **RC2**

Insonorizzazione fino a **47db**

Thermal transmittance up to $U_w = 1,3 \text{ W/m}^2\text{K}$

Air permeability up to Class 4

Impact water tightness up to Class 8A

Wind resistance up to Class C5 / B5

Anti-burglary RC2

Soundproofing up to 47db

Nodo Centrale

Central knot

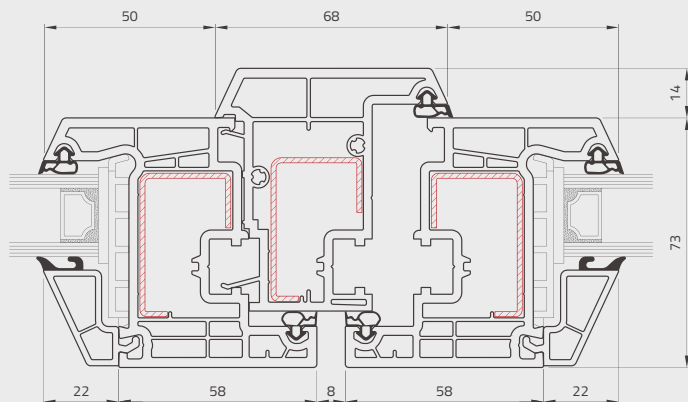

Telai

Frames

Telaio piano
Flat frame

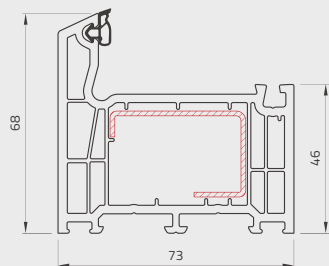

Telaio a ZETA 35 mm
ZETA frame 35mm

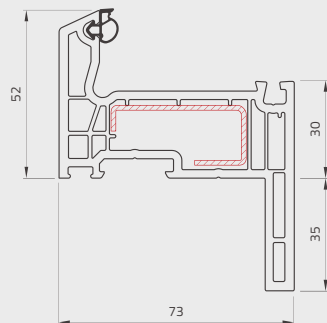

Telaio a ZETA 60 mm
ZETA frame 60mm

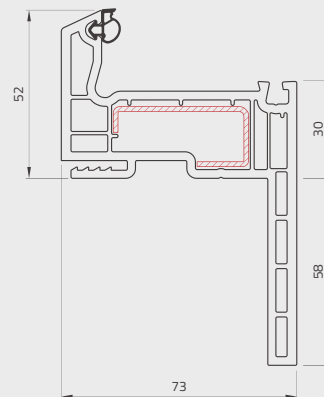

Fermavetri

Glazing bead

Arrotondato
Rounded

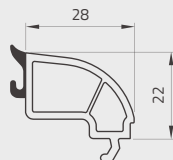

Trapezoidale
Trapezoidal

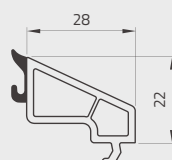

Trapezoidale
Trapezoidal



Spessore vetro 27-29mm
Glass thickness 27-29mm

Spessore vetro 35-37mm
Glass thickness 35-37mm